



Gorec

CEMENTNI IZDELKI

CENIK

2026

Vse cene so v evrih. Cenik velja od 1.3.2026 do preklica, oziroma objave novega cenika!

CEMENTNI IZDELKI GOREC d.o.o., ŠENTLOVRENC 21, 8212 VELIKA LOKA

Telefon: 07/30 48 350, 07/34 89 706, gsm: 041 629 714

www.gorec.info • info@gorec.eu

BETONSKI BLOKI



BETONSKI BLOK 30

MERE	CENA BREZ DDV	CENA Z DDV
29×39×19	1,25€	1,53€

Teža: 26 kg
48 kos/pal.
Teža palete: 1250 kg
poraba 12,5 kos na 1 m², 41,4 kos na 1m³



BETONSKI BLOK 25

MERE	CENA BREZ DDV	CENA Z DDV
24×39×19	1,14€	1,39€

Teža: 22,5 kg
60 kos/pal.
Teža palete: 1400 kg
poraba 12,5 kos na 1 m², 50 kos na 1 m³



BETONSKI BLOK 20

MERE	CENA BREZ DDV	CENA Z DDV
19×39×19	0,95€	1,16€

Teža: 17,5 kg
60 kos/pal.
Teža palete: 1100 kg
poraba 12,5 kos na 1 m², 62,5 kos na 1 m³



BETONSKI BLOK 12

MERE	CENA BREZ DDV	CENA Z DDV
12×39×19	0,81€	0,99€

Teža: 12,5 kg
90 kos/pal.
Teža palete: 1100 kg
poraba 12,5 kos na 1 m², 104 kos na 1 m³



OPAŽNI H BLOKI



OPAŽNI H BLOK 30

MERE	CENA BREZ DDV	CENA Z DDV
29×39×19	0,99€	1,21€

Teža: 15,5 kg
48 kos/pal.
Teža palete: 800 kg
poraba betona na 1 m² je 0,18 m³. 1 m³ zadostuje za 5,5 m².



OPAŽNI H BLOK 25

MERE	CENA BREZ DDV	CENA Z DDV
24×39×19	0,94€	1,15€

Teža: 14,5 kg
60 kos/pal.
Teža palete: 900 kg
poraba betona na 1 m² je 0,14 m³. 1 m³ zadostuje za 7,14 m²



OPAŽNI H BLOK 20

MERE	CENA BREZ DDV	CENA Z DDV
19×39×19	0,85€	1,04€

Teža: 13,5 kg
60 kos/pal.
Teža palete: 850 kg
poraba betona na 1 m² je 0,103 m³. 1 m³ zadostuje za 9,7 m².



OPEČNO BETONSKI VOGALNIKI**OPEČNI VOGALNIK 30**

Teža: 22 kg
48 kos/pal.
Teža palete: 1050 kg

MERE
29×39×19

CENA BREZ DDV
1,33€

CENA Z DDV
1,62€

**OPEČNI VOGALNIK 25**

Teža: 17 kg
60 kos/pal.
Teža palete: 1050 kg

MERE
24×39×19

CENA BREZ DDV
1,18€

CENA Z DDV
1,44€

**OPEČNI VOGALNIK 20**

Teža: 14 kg
60 kos/pal.
Teža palete: 840 kg

MERE
19×39×19

CENA BREZ DDV
1,03€

CENA Z DDV
1,26€

**VOGALNI BLOK G25**

Teža: 22 kg
48kos/pal.
Teža palete: 1050 kg

MERE
25×38×23,8

CENA BREZ DDV
1,65€

CENA Z DDV
2,01€

**VOGALNI BLOK G19**

Teža: 13,5 kg
80kos/pal.
Teža palete: 1050 kg

MERE
19×29×23,8

CENA BREZ DDV
1,37€

CENA Z DDV
1,67€

**VOGALNI BLOK G30**

Teža: 25,5 kg
54 kos/pal.
Teža palete: 1350 kg

MERE
39×29×23,8

CENA BREZ DDV
1,72€

CENA Z DDV
2,10€

**VOGALNI BLOK 29**

Teža: 25 kg
48 kos/pal.
Teža palete: 1200 kg

MERE
39×29×23,8

CENA BREZ DDV
1,72€

CENA Z DDV
2,10€



BETONSKI VOGALNIKI



BETONSKI VOGALNIK 30

Teža: 23 kg
48 kos/pal.
Teža palete: 1100 kg

MERE CENA BREZ DDV CENA Z DDV
29×39×19 1,25€ 1,53€



3 830043 540150 >



BETONSKI VOGALNIK25

Teža: 18 kg
60 kos/pal.
Teža palete: 1050 kg

24×39×19 1,14€ 1,39€



3 830043 540167 >



BETONSKI VOGALNIK 20

Teža: 14 kg
60 kos/pal.
Teža palete: 850 kg

19×39×19 0,95€ 1,16€



3 830043 540174 >

BETONSKI ROBNIKI (dvoslojni)



BETONSKI ROBNIK 5,5/20

polkrožni
Teža: 22,5 kg
48 kos/pal.
Teža palete: 1100 kg

5,5×100×20 2,15€ 2,62€



3 830043 540303 >



BETONSKI ROBNIK 5,5/20

ravni
Teža: 22,5 kg
48 kos/pal.
Teža palete: 1100 kg

5,5×100×20 2,15€ 2,62€



3 830043 540532 >



BETONSKI ROBNIK 5,5/20

ravni - črne barve
Teža: 22,5 kg
48 kos/pal.
Teža palete: 1100 kg

5,5×100×20 3,69€ 4,50€



3 830043 540266 >



BETONSKI ROBNIK 5,5/25

polkrožni
Teža: 28 kg
48 kos/pal.
Teža palete: 1350 kg

5,5×100×24,5 2,75€ 3,36€



3 830043 540310 >



BETONSKI ROBNIK 5,5/29

ravni
Teža: 34 kg
32 kos/pal.
Teža palete: 1100 kg

5,5×100×29 3,65€ 4,45€



3 830043 540495 >

BETONSKI ROBNIK (dvoslojni)



BETONSKI ROBNIK 6

poševni
Teža: 27 kg
54 kos/pal.
Teža palete: 1450 kg

MERE
6×100×20

CENA BREZ DDV
3,05€

CENA Z DDV
3,72€



BETONSKI ROBNIK 8

poševni
Teža: 34 kg
42 kos/pal.
Teža palete: 1450 kg

8×100×20

3,60€ 4,39€



BETONSKI ROBNIK 8

ravni
Teža: 36 kg
42 kos/pal.
Teža palete: 1512 kg

8×100×20

3,60€ 4,39€



BETONSKI ROBNIK 8

ravni - črne barve
Teža: 36 kg
42 kos/pal.
Teža palete: 1512 kg

8×100×20

5,28€ 6,44€



Izdelava samo po predhodnem naročilu.

BETONSKI ROBNIK 10

poševni
Teža: 52 kg
30 kos/pal.
Teža palete: 1550 kg

10×100×24,5

4,85€ 5,92€



BETONSKI ROBNIK 12

poševni
Teža: 62 kg
24 kos/pal.
Teža palete: 1500 kg

12×100×24,5

5,90€ 7,20€



BETONSKI ROBNIK 15

poševni
Teža: 82 kg
18 kos/pal.
Teža palete: 1500 kg

15×100×24,5

7,99€ 9,75€



BETONSKI ROBNIK 15

poševni z utorom
Teža: 82 kg
18 kos/pal.
Teža palete: 1500 kg

15×100×24,5

7,99€ 9,75€



BETONSKI ROBNIK (dvoslojni)

	MERE	CENA BREZ DDV	CENA Z DDV
 BETONSKI ROBNIK 15 poševni odtočni Teža: 70 kg 18kos/pal. Teža palete: 1300 kg	15×100×24,5	11,90€	14,52€
			 3 830043 540389 >
 BETONSKI ROBNIK 15 poševni odtočni z utorom Teža: 70 kg 18 kos/pal. Teža palete: 1300 kg	15×100×24,5	11,90€	14,52€
			 3 830043 540396 >
 BETONSKI ROBNIK 15/50 poševni Teža: 41 kg 40 kos/pal. Teža palete: 1750 kg	15×50×24,5	5,85€	7,14€
			 3 830043 540419 >
 BETONSKI ROBNIK 15/25 poševni Teža: 21 kg 60 kos/pal. Teža palete: 1300 kg	15×24,5×24,5	3,60€	4,39€
			 3 830043 540402 >
 BETONSKI ROBNIK 6/33 poševni Teža: 9 kg	6×33×20	1,65€	2,01€
			 3 830043 540426 >
 BETONSKI ROBNIK 8/33 poševni Teža: 11 kg	8×33×20	2,00€	2,44€
			 3 830043 540433 >
 BETONSKI ROBNIK 10/33 poševni Teža: 17 kg	10×33×24,5	2,95€	3,60€
			 3 830043 540440 >
 BETONSKI ROBNIK 12/33 poševni Teža: 21 kg	12×33×24,5	4,15€	5,06€
			 3 830043 540457 >



PALISADA SIVA

Teža: 4,7 kg

Višina: 24,5 cm

Premer: 11 cm

Teža palete: 1260 kg

Koristna dolžina 9,6 cm

Koristna dolžina 10 palisad v ravni liniji: 96 cm

MERE	CENA BREZ DDV	CENA Z DDV
11x24,5	1,45€	1,77€



LOMLJENI ŠKARPNIKI



LOMLJENI ŠKARPNIK

Teža: 23 kg

42 kos/pal.

Teža palete: 1000 kg

poraba 28 kos/m²

14x25x32	1,98€	2,42€
----------	-------	-------

SIVI



ORANŽNI

	2,68€	3,27€
--	-------	-------



KAPA ZA ŠKARPNIKE

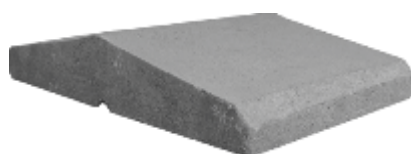

KAPA ZA ŠKARPNIKE

Teža: 12,5 kg

96 kos/pal.

Teža palete: 1200 kg

39x25x7	3,70€	4,51€
---------	-------	-------

SIVA



OKRASNI ZIDAK URBAN



Okrasni zidak Urban
Barva : MIX (sivo-črna)
cena za kos

Okrasni zidak Urban
Barva : MIX jesensko listje
(oranžna, rjava, črna)
cena za kos

39X19,5X16 19,5X19,5X16	2,38€	2,90€
----------------------------	-------	-------





škarpANTIK
Barva : MIX (sivo-črna)
cena za m²

MERE
20x35/25/15x17,5

CENA BREZ DDV

63,90€

CENA Z DDV

77,96€



škarpANTIK
Barva : MIX jesensko listje
(oranžna, rjava, črna)
cena za m²

20x35/25/15x17,5

73,90€

90,16€



škarpANTIK
NEOBDELAN/NEOBTOLČEN
Barva : MIX (sivo-črn)
cena za m²

20x35/25/15x17,5

45,00€

54,90€



škarpANTIK
NEOBDELAN/NEOBTOLČEN
Barva : MIX jesensko listje
(oranžna, rjava, črna)
cena za m²

20x35/25/15x17,5

55,00€

67,10€



TRAVNE PLOŠČE



TRAVNA PLOŠČA 10

40x60x10

3,28€

4,00€

Teža: 32 kg

40 kos/pal.

Teža palete: 1300 kg

poraba na m²: 4,16 kos



TRAVNA PLOŠČA 8

40x60x8

2,92€

3,56€

Teža: 27 kg

40 kos/pal.

Teža palete: 1100 kg

poraba na m²: 4,16 kos



LOMLJENI ZIDAKI (sivo - črni)



LOMLJENI ZIDAK ENOSTRANSKI

Teža: 18 kg
72 kos/pal.
Teža palete: 1300 kg

poraba 15,6 kos/m², poraba betona na 1m² je 0,07 m³. 1 m³ zadostuje za 14 m²

MERE
40×20×16

CENA BREZ DDV
3,36€

CENA Z DDV
4,10€



3 830043 544349 >

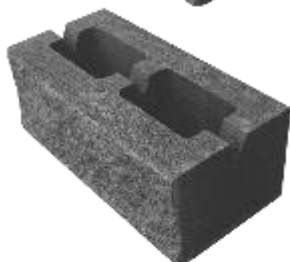

LOMLJENI ZIDAK DVOSTRANSKI

Teža: 18 kg
60 kos/pal.
Teža palete: 1100 kg

poraba 15,6 kos/m², poraba betona na 1m² je 0,07 m³. 1 m³ zadostuje za 14 m²

40×20×16

4,00€

4,88€



3 830043 544356 >



LOMLJENI ZIDAK ŠTIRISTRANSKI

Teža: 18 kg
60 kos/pal.
Teža palete: 1100 kg

poraba 15,6 kos/m², poraba betona na 1m² je 0,07 m³. 1 m³ zadostuje za 14 m²

40×20×16

7,25€

8,85€



3 830043 547005 >



LOMLJENI ZIDAK trapezoidni

Teža: 14 kg
90 kos/pal.
Teža palete: 1300 kg

poraba 25 kos/m²

29/25×20×16

3,36€

4,10€



3 830043 544363 >

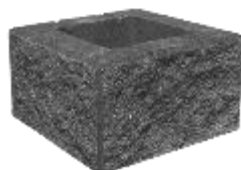

LOMLJENI ZIDAK - STEBER

Teža: 20 kg
72 kos/pal.
Teža palete: 1450 kg

28×28×16

6,78€

8,27€



3 830043 544370 >

LOMLJENI ZIDAKI

jesensko listje
oranžna, rjava, črna



LOMLJENI ZIDAK ENOSTRANSKI

Teža: 18 kg
72 kos/pal.
Teža palete: 1300 kg

poraba 15,6 kos/m², poraba betona na 1m² je 0,07 m³. 1 m³ zadostuje za 14 m²

40×20×16

3,75€

4,58€



3 830043 548200 >

LOMLJENI ZIDAK DVOSTRANSKI

Teža: 18 kg
60 kos/pal.
Teža palete: 1100 kg

poraba 15,6 kos/m², poraba betona na 1m² je 0,07 m³. 1 m³ zadostuje za 14 m²

40×20×16

4,65€

5,67€



3 830043 548217 >



**LOMLJENI ZIDAK
ŠTIRISTRANSKI**

Teža: 18 kg

60 kos/pal.

Teža palete: 1100 kg

poraba 15,6 kos/m², poraba betona na 1m² je 0,07 m³. 1 m³ zadostuje za 14 m²

MERE	CENA BREZ DDV	CENA Z DDV
40×20×16	8,50€	10,37€



3 830043 544325 >

KAPE ZA OPAŽNE BLOKE IN LOMLJENE ZIDAKE (sivo - črni)

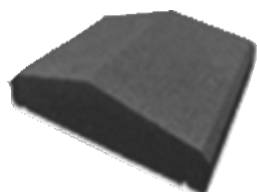

KAPA POŠEVNA PREŠANA

40×30×7

5,30€ 6,47€

40 × 30

Teža: 16 kg



3 830043 544417 >

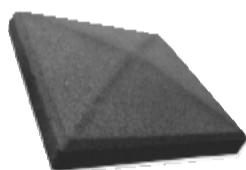

**KAPA STEBER POŠEVNA
PREŠANA**

39×39×7

7,80€ 9,52€

Teža: 19 kg



3 830043 544424 >

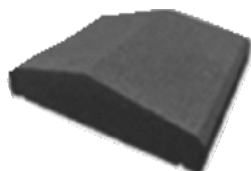

**KAPA TRAPEZ POŠEVNA
PREŠANA**

29/25×30×7

4,20€ 5,12€

Teža: 11 kg



3 830043 544431 >

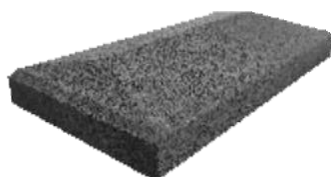

**KAPA 50 × 30 - ŠTIRISTRANSKO
POŠEVNO PREŠANA**

Teža: 20 kg

7,80€ 9,52€



3 830043 549504 >

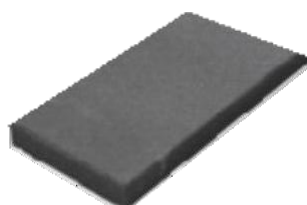

KAPA 50 × 30 - RAVNA PREŠANA

Teža: 20 kg

6,50€ 7,93€



3 830043 544110 >

	MERE	CENA BREZ DDV	CENA Z DDV
 KAPA STEBER RAVNA PREŠANA Teža: 18 kg	38X38X6	7,80€	9,52€
		 3 830043 547784 >	
 KAPA 50X30 ŠTIRISTRANSKA RAVNA PREŠANA Teža: 18 kg	50X30X6	7,80€	9,52€
		 3 830043 547777 >	
 KAPA TRAPEZ RAVNA PREŠANA Teža: 10 kg	30/24X30X6	4,20€	5,12€
		 3 830043 547791 >	
 KAPA LITA SIVA 30 Teža: 26,4 kg 45 kos/pal.	100×30×6,5	12,50€	15,25€
		 3 830043 544905 >	
 KAPA LITA SIVA 35 Teža: 31,6 kg 45 kos/pal.	100×35×6,5	14,60€	17,81€
		 3 830043 544912 >	
 KAPA LITA SIVA 40 Teža: 37,6 kg 30 kos/pal.	100×40×6,5	16,50€	20,13€
		 3 830043 544929 >	
PRŠILKA ZA IMPREGNACIJO 0,5L		9,90€	12,08€
		 3 830043 548927 >	
IMPREGNACIJA 5L		58,90€	71,86€
		 3 830043 548934 >	

OBLOŽNI ELEMENTI (sivo-črni)

MERE CENA BREZ DDV CENA Z DDV



OBLOŽNI ELEMENT 28 28x5,5x16 **13,90€** **16,96€**

Teža: 5 kg

pakirano na paleti 300 kos, teža palete 1520 kg

22 kosov na 1 m², 13,44 m² na paleti

Cena je za m²



3 830043 546015 >



OBLOŽNI ELEMENT 40 40x5,5x16 **13,90€** **16,96€**

Teža: 8 kg

pakirano 180 kosov na paleti, teža palete 1460 kg

15,6 kosa na m², 11,5 m² na paleti

Cena je za m²



3 830043 546006 >

POHODNA PLOŠČA



POHODNA PLOŠČA 60x30x5 **2,95€** **3,60€**

Teža: 20 kg

Na paleti: 8,64 m²/48 kom

Barva: mix (siva - črna)



3 830043 548897 >

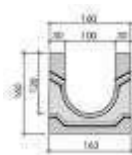

KANALETA BASIC+ 100

A15

pocinkana

Teža: 38 kg/kom

Na paletu: 35 kom

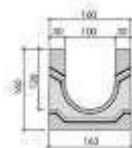

KANALETA BASIC+ 100

B125

pocinkana

Teža: 41 kg/kom

Na paletu: 35 kom

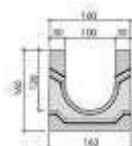

KANALETA BASIC+ 100

B125

litoželezna

Teža: 42 kg/kom

Na paletu: 35 kom

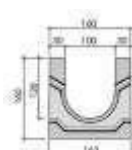

KANALETA BASIC+ 100

C250

litoželezna

Teža: 44 kg/kom

Na paletu: 35 kom

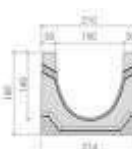

KANALETA BASIC+ 150

C250

litoželezna

Teža: 62,4 kg/kom

Na paletu: 20 kom

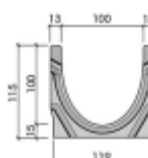

KANALETA FILCOTEN light 100

A15

pocinkana

Teža: 12 kg/kom

Na paletu: 64 kom

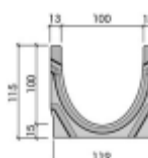

KANALETA FILCOTEN light 100

C250

litoželezna

Teža: kg/kom

Na paletu: 64 kom

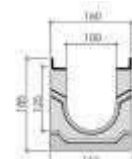

KANALETA SMART PRO 100

D400

litoželezna

Teža: 49 kg/kom

Na paletu: 35 kom



KANALETA SMART PRO 150

D400

litoželezna

Teža: 71 kg/kom

Na paletu: 20 kom

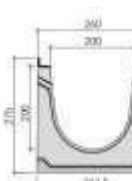

KANALETA SMART PRO 200

D400

litoželezna

Teža: 100 kg/kom

Na paletu: 12 kom



BETONSKE CEVI



CEV FI 30
Teža: 125 kg

DOLŽINA	CENA BREZ DDV	CENA Z DDV
1 METER	15,10€	18,42€



CEV FI 40
Teža: 170kg

DOLŽINA	CENA BREZ DDV	CENA Z DDV
1 METER	20,00€	24,40€



CEV FI 50
Teža: 230 kg

DOLŽINA	CENA BREZ DDV	CENA Z DDV
1 METER	23,80€	29,04€



CEV FI 60
Teža: 330 kg

DOLŽINA	CENA BREZ DDV	CENA Z DDV
1 METER	30,60€	37,33€



CEV FI 80
Teža: 530kg

DOLŽINA	CENA BREZ DDV	CENA Z DDV
1 METER	52,40€	63,93€



CEV FI 80 ARMIRANA
Teža: 530 kg
Izdelava samo po predhodnem naročilu.

DOLŽINA	CENA BREZ DDV	CENA Z DDV
1 METER	119,80€	146,16€



BETONSKE CEVI



CEV FI 100

Teža: 765kg

DOLŽINA	CENA BREZ DDV	CENA Z DDV
1 METER	65,00€	79,30€



CEV FI 100 ARMIRANA

Teža: 765 kg

Izdelava samo po predhodnem naročilu.

1 METER	138,90€	169,46€
---------	---------	---------



CEV FI 120

Teža: 1100 kg

1 METER	93,50€	114,07€
---------	--------	---------



CEV FI 120 ARMIRANA

Teža: 1100 kg

Izdelava samo po predhodnem naročilu.

1 METER	175,80€	214,48€
---------	---------	---------



BETONSKE CEVI



CEV FI 150

Teža: 1550 kg
Cev je minimalno armirana
(3 varnostni obroči)

DOLŽINA
1 METER

CENA BREZ DDV 195,00€
CENA Z DDV 237,90€



255,00€ 311,10€

CEV FI 150 ARMIRANA

Teža: 1550kg



CEV FI 200

Teža: 2200 kg
Cev je minimalno armirana
(4 varnostni obroči, 6 pokončnih palic)

1 METER

319,00€ 389,18€



419,00€ 511,18€

CEV FI 200 ARMIRANA

Teža: 2200kg



DRENAŽNE CEVI



CEV FI 50

Teža: 230kg

1 METER

31,70€ 38,67€



CEV FI 60

Teža: 330kg

1 METER

39,20€ 47,82€



CEV FI 80

Teža: 530 kg

1 METER

62,20€ 75,88€



DRENAŽNE CEVI

DOLŽINA CENA BREZ DDV CENA Z DDV



CEV FI 100
Teža: 765kg

1 METER

75,70€

92,35€



CEV FI 120
Teža: 1100kg

1 METER

105,90€

129,20€



CEV FI 150
Teža: 1550 kg
Cev je minimalno armirana
(3 varnostni obroči)

1 METER

235,00€

286,70€



CEV FI 150 ARMIRANA
Teža: 1550 kg
Izdelava samo po predhodnem naročilu.

1 METER

279,00€

340,38€



CEV FI 200
Teža: 2200 kg
Cev je minimalno armirana
(4 varnostni obroči, 6 pokončnih palic)

1 METER

359,00€

437,98€



CEV FI 200 ARMIRANA
Teža: 2200 kg
Izdelava samo po predhodnem naročilu.













1 METER

459,00€

559,98€



BETONSKE CEVI DOLŽINE 50 CM

		DOLŽINA	CENA BREZ DDV	CENA Z DDV
	CEV FI 30 Teža: 65 kg	50 CM	10,60€	12,94€
				 3 830043 542604 >
	CEV FI 40 Teža: 85kg	50 CM	13,90€	16,96€
				 3 830043 542611 >
	CEV FI 50 Teža: 120 kg	50 CM	17,20€	20,98€
				 3 830043 542635 >
	CEV FI 60 Teža: 170 kg	50 CM	24,50€	29,89€
				 3 830043 542659 >
	CEV FI 80 Teža: 265 kg	50 CM	40,40€	49,29€
				 3 830043 542642 >
	CEV FI 100 Teža: 385kg	50 CM	51,80€	63,20€
				 3 830043 542628 >

BETONSKE CEVI DOLŽINE 50 CM

DOLŽINA CENA BREZ DDV CENA Z DDV



CEV FI 120

Teža: 550 kg

50 CM

74,80€

91,26€



CEV FI 150

Teža: 800kg

Cev je minimalno armirana

(2 varnostna obroča)

50 CM

139,00€

169,58€



CEV FI 150 ARMIRANA

Teža: 800 kg

Izdelava samo po predhodnem naročilu.

50 CM

169,00€

206,18€



CEV FI 200

Teža: 1100 kg

Cev je minimalno armirana

(3 varnostni obroči, 6 pokončnih palic)

50 CM

229,00€

279,38€



CEV FI 200 ARMIRANA

Teža: 1100 kg

Izdelava samo po predhodnem naročilu.

50 CM

298,00€

363,56€



CEV Z ODTOČNIMI ODPRTINAMI



CEV FI 30

Teža: 60 kg

50 CM

13,90€

16,96€



CENA BREZ DDV CENA Z DDV



POKROV FI 30
Teža: 20 kg
kom. na paleti: 60 kom

7,45€ 9,09€



POKROV FI 40
Teža: 30 kg
kom. na paleti: 14 kom

10,70€ 13,05€



POKROV FI 50
Teža: 40 kg
kom. na paleti: 10 kom

15,85€ 19,34€

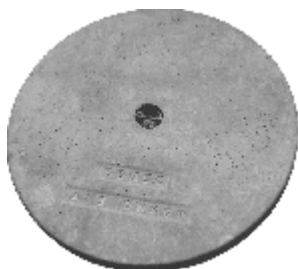

POKROV FI 60
Teža: 60 kg
kom. na paleti: 10 kom

22,40€ 27,33€



POKROV FI 80
Teža: 190 kg
kom. na paleti: 5 kom

39,50€ 48,19€

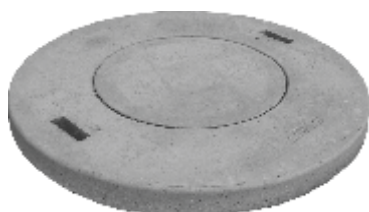

POKROV FI 100
Teža: 290 kg
kom. na paleti: 5 kom

50,40€ 61,49€

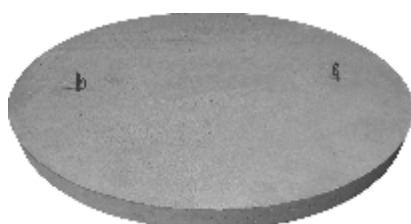

POKROV FI 120
Teža: 420 kg
kom. na paleti: 5 kom

69,70€ 85,03€



POKROVI

CENA BREZ DDV CENA Z DDV
175,00€ 213,50€

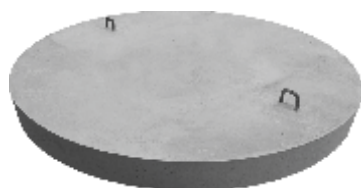

POKROV FI 150
Teža: 850 kg

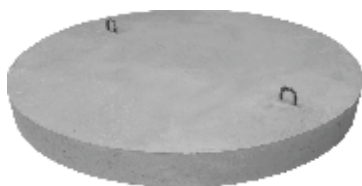

POKROV FI 200
Teža: 1500 kg

249,00€ 303,78€



POKROVI S ČISTILNO ODPRTINO



POKROV FI 80/50
Teža: 190 kg
kom. na paleti: 5 kom

49,50€ 60,39€



POKROV FI 100/50
Teža: 290 kg
kom. na paleti: 5 kom

59,00€ 71,98€

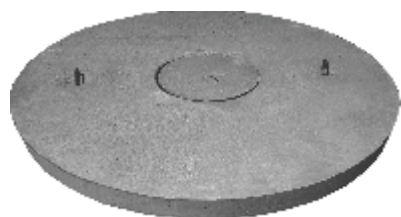

POKROV FI 120/50
Teža: 420 kg
kom. na paleti: 5 kom

94,90€ 115,78€



POKROV FI 120/60
Teža: 420 kg
kom. na paleti: 5 kom

99,00€ 120,78€

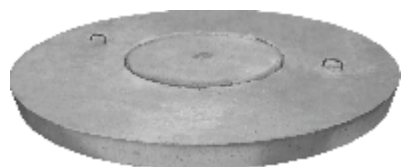

POKROV FI 150/60
Teža: 850 kg

192,00€ 234,24€

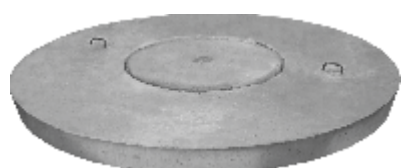

POKROV FI 200/60
Teža: 1500 kg

269,00€ 328,18€



POKROVI Z ODPRTINO ZA ŽLEB

CENA BREZ DDV

CENA Z DDV



POKROV FI 30

Teža: 15 kg

7,45€

9,09€



POKROV FI 40

Teža: 25 kg

10,70€

13,05€



POKROV FI 50

Teža: 42 kg

15,85€

19,34€





POSODA 3,9 M3

Teža: 6300 kg

Višina: 224 cm

FI: 224 cm

1210,00€ 1476,20€



POSODA 5,2 M3

Teža: 7300 kg

Višina: 267 cm

FI: 224 cm

1390,00€ 1695,80€



POSODA 6,9 M3

Teža: 8400 kg

Višina: 314 cm

FI: 224 cm

1670,00€ 2037,40€



CENA BREZ DDV

CENA Z DDV



MALI 4,7 M3
FI:228
VIŠINA: 233 CM
TEŽA:6,9 T

993,00€ 1211,46€



SREDNJI 7,8 M3
FI:228
VIŠINA: 333 CM
TEŽA: 9,1 T

1312,00€ 1600,64€



VELIKI 11 M3
FI:228
VIŠINA: 433 CM
TEŽA: 11,3 T

1631,00€ 1989,82€



BETONSKI POKROV FI 200
S POLOVIČNO CEVJO FI 60
TEŽA: 2100 KG

275,00€ 335,50€



BETONSKA CEV FI 200,
VIŠINA 50 CM,
TEŽA: 1100 KG

229,00€ 279,38€



BETONSKA CEV FI 200,
VIŠINA 100 CM,
TEŽA: 2200 KG

319,00€ 389,18€



BETONSKA CEV FI 200,
VIŠINA 50 CM, ARMIRANA,
Z DNOM
TEŽA: 2600 KG, DEBELINA DNA 15 CM

399,00€ 486,78€



Solido[®]

SMART

A PREMIER TECH BRAND

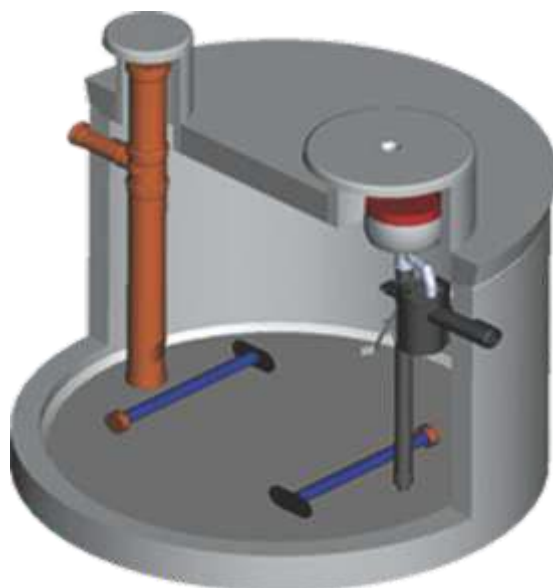

**BIOLOŠKA ČISTILNA NAPRAVA
SOLIDO SMART
V BETONSKEM REZERVOARJU
2-5 PE
TEŽA 6300 kg, VIŠINA 224 CM, FI 224 CM**

CENA BREZ DDV CENA Z DDV

3070,00€ 3745,40€



**BIOLOŠKA ČISTILNA NAPRAVA
SOLIDO SMART COMPACT
V BETONSKEM REZERVOARJU
6-8 PE
TEŽA 7300 kg, VIŠINA 267 CM, FI 224 CM**

3395,00€ 4141,90€



**BIOLOŠKA ČISTILNA NAPRAVA
SOLIDO SMART
V BETONSKEM REZERVOARJU
9-10 PE
TEŽA 8400 kg, VIŠINA 314 CM, FI 224 CM**

3860,00€ 4709,20€





MERE CENA BREZ DDV CENA Z DDV

MONTAŽNI BLOK 60 60×60×60 **48,00€** **58,56€**
TEŽA 570 kg



MONTAŽNI BLOK 120 120×60×60 **90,00€** **109,80€**
TEŽA 1140 kg



MONTAŽNI BLOK 180 180×60×60 **127,00€** **154,94€**
TEŽA 1700 kg



MONTAŽNI BLOK 80 80×80×80 **103,00** **125,66€**
TEŽA 1200 kg



MONTAŽNI BLOK 160 160×80×80 **176,00€** **214,72€**
TEŽA 1700 kg



LESENA PALETA

5,50€ **6,71€**



NOTRANJE DIMENZIJE v cm	DEBELINA STEN	TEŽA	CENA brez DDV	CENA z DDV
30 x 30 x 27	3,0 cm	45 kg	8,90 €	10,86 €
				 3 830043 548521 >
40 x 40 x 36	4,0 cm	83 kg	12,40 €	15,13 €
				 3 830043 548538 >
50 x 50 x 45,5	4,5 cm	150 kg	20,50 €	25,01 €
				 3 830043 548620 >
60 x 60 x 54,5	5,5 cm	235 kg	28,90 €	35,26 €
				 3 830043 548613 >
80 x 80 x 74	6,0 cm	510 kg	59,00 €	71,98 €
				 3 830043 548569 >
100 x 100 x 94	9,0 cm	970 kg	119,00 €	145,18 €
				 3 830043 548576 >

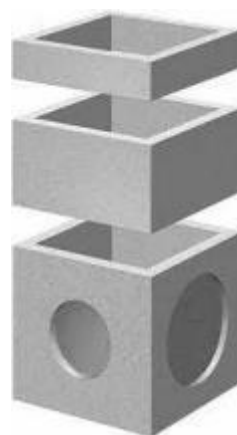





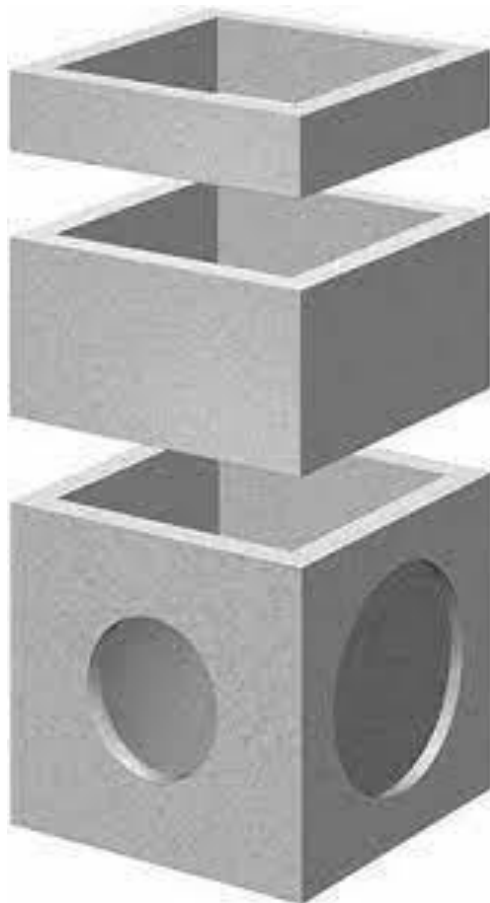

NOTRANJE DIMENZIJE v cm	DEBELINA STEN	TEŽA	CENA brez DDV	CENA z DDV
30 x 30 x 30	3,0 cm	39 kg	8,90 €	10,86 €
				 3 830043 548828 >
40 x 40 x 20	3,5 cm	34 kg	10,90 €	13,30 €
				 3 830043 548637 >
40 x 40 x 40	3,5 cm	72 kg	12,40 €	15,13 €
				 3 830043 548811 >
50 x 50 x 20	4,5 cm	51 kg	17,50 €	21,35 €
				 3 830043 548644 >
50 x 50 x 50	4,5 cm	131 kg	19,50 €	23,79 €
				 3 830043 548989 >
60 x 60 x 20	5,5 cm	71 kg	19,90 €	24,28 €
				 3 830043 548668 >
60 x 60 x 60	5,5 cm	210 kg	26,90 €	32,82 €
				 3 830043 548804 >
80 x 80 x 20	6,0 cm	110 kg	49,00 €	59,78 €
				 3 830043 548767 >

NOTRANJE DIMENZIJE v cm	DEBELINA STEN	TEŽA	CENA brez DDV	CENA z DDV
80 x 80 x 80	6,0 cm	440 kg	59,00 €	71,98 €
				 3 830043 548798 >
100 x 100 x 20	7,5 cm	165 kg	49,00 €	59,78 €
				 3 830043 549405 >
100 x 100 x 50	7,5 cm	400 kg	62,00 €	75,64 €
				 3 830043 548644 >
100 x 100 x 100	7,5 cm	810 kg	109,00 €	132,98 €
				 3 830043 548781 >













POKROVI Z ODPRTINO TANKOSTENSKI

POKROV ZA JAŠEK v cm	DEBELINA STEN	TEŽA	CENA brez DDV	CENA z DDV
37 x 37 (za jašek 30)	6,0 cm	18 kg	7,90 €	9,64 €
			 3 830043 549412 >	
48 x 48 (za jašek 40)	7,0 cm	29 kg	10,90 €	13,30 €
			 3 830043 548958 >	
58 x 58 (za jašek 50)	8,0 cm	45 kg	14,90 €	18,18 €
			 3 830043 549429 >	
70 x 70 (za jašek 60)	8,0 cm	84 kg	20,90 €	25,50 €
			 3 830043 548972 >	
95 x 95 (za jašek 80)	9,5 cm	210 kg	46,00 €	56,12 €
			 3 830043 549436 >	
119 x 119 (za jašek 100)	9,5 cm	300 kg	56,00 €	68,32 €
			 3 830043 548927 >	
149 x 149 (za jašek 120)	9,5 cm	420 kg	89,90 €	109,68 €
			 3 830043 549443 >	



POKROVI Z REŠETKO TANKOSTENSKI





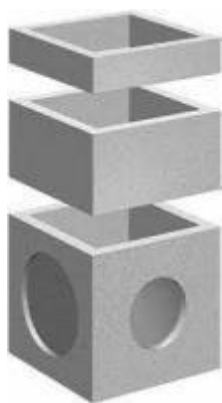

POKROV ZA JAŠEK v cm	DEBELINA STEN	TEŽA	CENA brez DDV	CENA z DDV
37 x 37 (za jašek 30)	6,0 cm	18 kg	7,90 €	9,64 €
				 3 830043 549450 >
48 x 48 (za jašek 40)	7,0 cm	29 kg	9,90 €	12,08 €
				 3 830043 549467 >
58 x 58 (za jašek 50)	8,0 cm	45 kg	14,90 €	18,18 €
				 3 830043 549474 >
70 x 70 (za jašek 60)	8,0 cm	84 kg	20,90 €	25,50 €
				 3 830043 549481 >

POKROV ZA JAŠEK v cm	DEBELINA STEN	TEŽA	CENA brez DDV	CENA z DDV
60 x 60 x 55	8,0 cm	400 kg	69,00 €	84,18 €
				 3 830043 548583 >
80 x 80 x 75	10,0 cm	795 kg	119,00 €	145,18 €
				 3 830043 548590 >
100 x 100 x 90	13,0 cm	1550 kg	199,00 €	242,78 €
				 3 830043 548606 >
120 x 120 x 105	14,0 cm	2100 kg	249,00 €	303,78 €
				 3 830043 548545 >
150 x 150 x 100	15,0 cm	2900 kg	339,00 €	413,58 €
				 3 830043 549627 >
DNO 200 x 200 x 20	20,0 cm	2700 kg	329,00 €	401,38 €
				 3 830043 549634 >
PODALJŠEK 200 x 200 x 100	14,0 cm	2900 kg	389,00 €	474,58 €
				 3 830043 549641 >







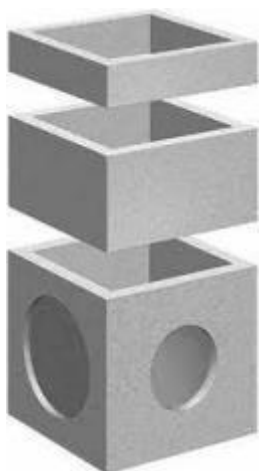

POKROV ZA JAŠEK v cm	DEBELINA STEN	TEŽA	CENA brez DDV	CENA z DDV
60 x 60 x 25	8,0 cm	95 kg	32,90 €	40,14 €
				 3 830043 548682 >
60 x 60 x 40	8,0 cm	180 kg	49,90 €	60,88 €
				 3 830043 548699 >
80 x 80 x 20	10,0 cm	150 kg	38,90 €	47,46 €
				 3 830043 548705 >
80 x 80 x 40	10,0 cm	300 kg	63,90 €	77,96 €
				 3 830043 548712 >
80 x 80 x 88	10,0 cm	650 kg	109,90 €	134,08 €
				 3 830043 548729 >
100 x 100 x 20	13,0 cm	270 kg	78,00 €	95,16 €
				 3 830043 549405 >
100 x 100 x 40	13,0 cm	460 kg	92,00 €	112,24 €
				 3 830043 548736 >
100 x 100 x 100	13,0 cm	1100 kg	189,90 €	231,68 €
				 3 830043 549498 >

PODALJŠEK DEBELOSTENSKI

POKROV ZA JAŠEK v cm	DEBELINA STEN	TEŽA	CENA brez DDV	CENA z DDV
120 x 120 x 40	13,0 cm	470 kg	134,00€	163,48 €
				 3 830043 548743 >
120 x 120 x 120	13,0 cm	1700 kg	229,00 €	279,38 €
				 3 830043 548842 >
150 x 150 x 50	15,0 cm	1070 kg	169,00 €	206,18 €
				 3 830043 548774 >
150 x 150 x 110	15,0 cm	2300 kg	289,00 €	352,58 €
				 3 830043 548835 >
200 x 200 x 50	14,0 cm	1450 kg	299,00 €	364,78 €
				 3 830043 549504 >
200 x 200 x 100	14,0 cm	2900 kg	389,00 €	474,58 €
				 3 830043 549511 >



POKROVI Z ODPRTINO DEBELOSTENSKI

POKROV ZA JAŠEK v cm	DEBELINA STEN	TEŽA	CENA brez DDV	CENA z DDV
70 x 70 (za jašek 60)	12,0 cm	130 kg	32,00 €	39,04 €
				 3 830043 549528 >
95 x 95 (za jašek 80)	14,0 cm	265 kg	63,00 €	76,86 €
				 3 830043 549535 >
120 x 120 (za jašek 100)	14,0 cm	440 kg	129,00	157,38
				 3 830043 548651 >
145 x 145 (za jašek 120)	20,0 cm	890 kg	189,00 €	230,58 €
				 3 830043 548996 >
180 x 180 (za jašek 150)	20,0 cm	1540 kg	249,00 €	303,78 €
				 3 830043 548637 >
230 x 230 (za jašek 200)	20,0 cm	2700 kg	369,00 €	450,18 €
				 3 830043 549542 >



DIMENZIJE v cm	c x d v cm	Fl v cm	TEŽA	CENA brez DDV	CENA z DDV
60 x 100 x 60	27 x 28	20	500 kg	94,00 €	114,68 €
					
80 x 70 x 80	30 x 30	20	870 kg	129,00 €	157,38 €
					
90 x 70 x 80	40 x 40	22	840 kg	149,00 €	181,78 €
					
105 x 60 x 73	40 x 40	28	680 kg	119,00 €	145,18 €
					
115 x 68 x 100	40 x 40	28	1280 kg	205,00 €	250,10 €
					
100 x 100 x 100	40 x 40	35	1840 kg	269,00 €	328,18 €
					
48 x 65 x 48	30 x 30	18	285 kg	99,00 €	120,78 €

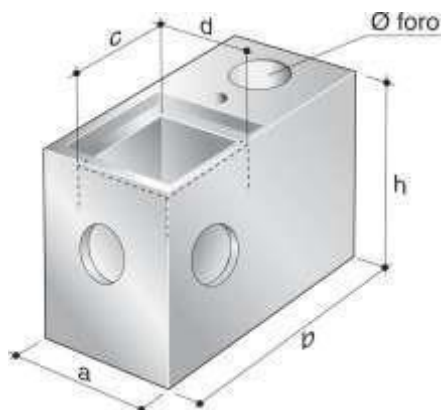

Gorec

CEMENTNI IZDELKI

SVETOVANJE, PONUDBA IN DODATNE INFORMACIJE:

041 629 714
07 30 48 350
07 34 89 706
info@gorec.eu
j.gorec@siol.net
maja.gorec@siol.net

SVETOVANJE, PONUDBA IN DODATNE INFORMACIJE: MALE ČISTILNE NAPRAVE, ZBIRALNIKI VODE IN OLJNI LOVILCI

DEJAN PROSEN • 040 797 323 • d.prosen@gorec.eu • cistilne@gorec.eu

DELOVNI ČAS ŠENTLOVRENC:

PON - PET 6:00 - 17:00
SOB. 7:00 - 12:00

DELOVNI ČAS PE IVANČNA GORICA:

PON - PET 6:00 - 15:00



Gorec

CEMENTNI IZDELKI

HVALA ZA ZAUPANJE

Vse cene so v evrih. Cenik velja od 1.3.2026 do preklica, oziroma objave novega cenika!

CEMENTNI IZDELKI GOREC d.o.o., ŠENTLOVRENC 21, 8212 VELIKA LOKA

Telefon: 07/30 48 350, 07/34 89 706, gsm: 041 629 714

www.gorec.info • info@gorec.eu